

AMP
EU Version

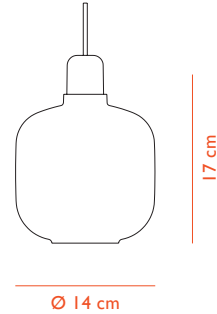

Amp Pendant Small - EU Version



DESCRIPTION

Amp is a collection of lamps inspired by old tube amplifiers from the 1960s. The sophisticated range is characterized by its high-quality materials of glass, brass and marble that add a visual fragility and sensuous heaviness. Amp has a nostalgic and at the same time, contemporary feel.

DESIGN

Simon Legald, 2014

MATERIAL

Glass / Marble / Brass Plated Steel

CONSTRUCTION

The Amp collection consists of five lamps, which all follow the simple construction of a glass shade slipped over a marble or brass base. The shape of each part ensures stability and easy handling.

MAINTENANCE

Clean with damp cloth. Avoid use of all-purpose cleaners and other degreasing detergents.

CORD

4 m textile cord (gold glass - green cord / smoked glass - black cord / white glass - white cord).

CANOPY

Included, black or white color, H: 7,7 x Ø: 9 cm 0,04 kg

DIMMABLE FUNCTION

Yes - with dimmable light source. Ensure the dimmer is suitable for LED.

VOLTAGE

220-240V

MAX LOAD

40 W

FREQUENCY

50/60 Hz

IP RATING

IP20

CLASSIFICATION

Class II

SOCKET

E14

LIGHT SOURCE - RECOMMENDED

Art. No.: 504050 LED E14 EU, dimmable

Power: 1,5 W

CCT: 2000K

Output: 100 lm

Life Span: 15 000 h

CRI: > 90

GENERAL STANDARD & CERTIFICATES

EN 60598-1:2008+All:2009

EN 60598-2-1: 1989

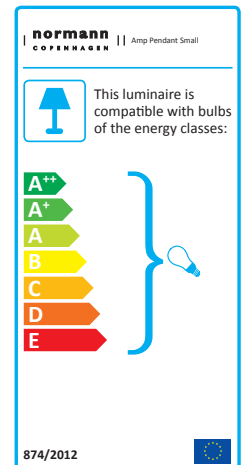

COLOR



White Glass /
White Marble



Smoke Glass /
Black Marble



Gold Glass /
Green Marble



White Glass /
Brass



Smoke Glass /
Brass

Amp Pendant Large - EU Version



DESCRIPTION

Amp is a collection of lamps inspired by old tube amplifiers from the 1960s. The sophisticated range is characterized by its high-quality materials of glass, brass and marble that add a visual fragility and sensuous heaviness. Amp has a nostalgic and at the same time, contemporary feel.

DESIGN

Simon Legald, 2014

MATERIAL

Glass / Marble / Brass Plated Steel

CONSTRUCTION

The Amp collection consists of five lamps, which all follow the simple construction of a glass shade slipped over a marble or brass base. The shape of each part ensures stability and easy handling.

MAINTENANCE

Clean with damp cloth. Avoid use of all-purpose cleaners and other degreasing detergents.

CORD

4 m textile cord (gold glass - green cord / smoked glass - black cord / white glass - white cord).

CANOPY

Included, black or white color, H: 7,7 x Ø: 9 cm 0,04 kg

DIMMABLE FUNCTION

Yes - with dimmable light source. Ensure the dimmer is suitable for LED.

VOLTAGE

220-240V

MAX LOAD

40 W

FREQUENCY

50/60 Hz

IP RATING

IP20

CLASSIFICATION

Class II

SOCKET

E14

LIGHT SOURCE - RECOMMENDED

Art. No.: 504050 LED E14 EU, dimmable

Power: 1,5 W

CCT: 2000K

Output: 100 lm

Life Span: 15 000 h

CRI: > 90

GENERAL STANDARD & CERTIFICATES

EN 60598-1:2008+All:2009

EN 60598-2-1: 1989

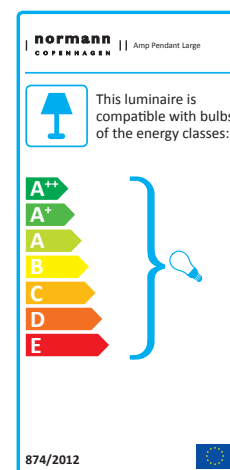

COLOR



White Glass /
White Marble



Smoke Glass /
Black Marble



Gold Glass /
Green Marble



White Glass /
Brass



Smoke Glass /
Brass

Amp Table Lamp - EU Version

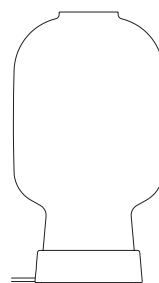

26,5 cm

Ø 14 cm

DESCRIPTION

Amp is a collection of lamps inspired by old tube amplifiers from the 1960s. The sophisticated range is characterized by its high-quality materials of glass, brass and marble that add a visual fragility and sensuous heaviness. Amp has a nostalgic and at the same time, contemporary feel.

DESIGN

Simon Legald, 2014

MATERIAL

Glass / Marble / Brass Plated Steel

CONSTRUCTION

The Amp collection consists of five lamps, which all follow the simple construction of a glass shade slipped over a marble or brass base. The shape of each part ensures stability and easy handling.

MAINTENANCE

Clean with damp cloth. Avoid use of all-purpose cleaners and other degreasing detergents.

CORD

2 m textile cord with switch (gold glass - green cord / smoked glass - black cord / white glass - white cord).

DIMMABLE FUNCTION

No

VOLTAGE

220-240V

MAX LOAD

40 W

FREQUENCY

50/60 Hz

IP RATING

IP20

CLASSIFICATION

Class II

SOCKET

E14

LIGHT SOURCE - RECOMMENDED

Art. No.: 504050 LED E14 EU, dimmable

Power: 1,5 W

CCT: 2000 K

Output: 100 lm

Life Span: 15 000 h

CRI: > 90

GENERAL STANDARD & CERTIFICATES

EN 60598-1:2008+All:2009

EN 60598-2-4: 1997

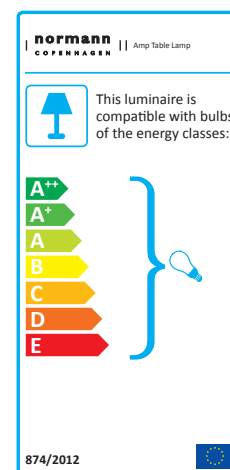

COLOR



White Glass /
White Marble



Smoke Glass /
Black Marble



Gold Glass /
Green Marble



White Glass /
Brass



Smoke Glass /
Brass

Amp Chandelier Small - EU Version

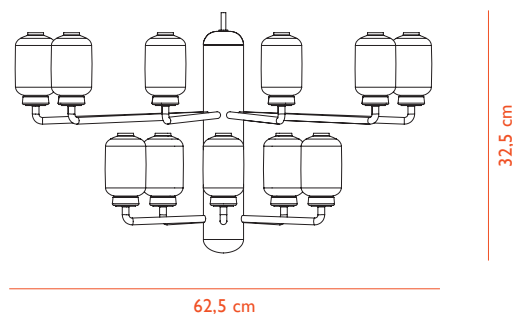
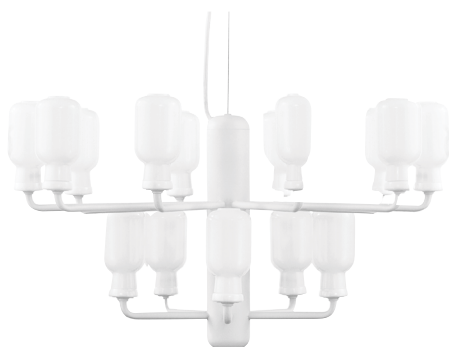

DESCRIPTION

Amp is a collection of lamps inspired by old tube amplifiers from the 1960s. The sophisticated range is characterized by its high-quality materials of glass, brass and marble that add a visual fragility and sensuous heaviness. Amp has a nostalgic and at the same time, contemporary feel.

DESIGN

Simon Legald, 2014

MATERIAL

Glass / Marble / Brass Plated Steel

CONSTRUCTION

The Amp collection consists of five lamps, which all follow the simple construction of a glass shade slipped over a marble or brass base. The shape of each part ensures stability and easy handling.

MAINTENANCE

Clean with damp cloth. Avoid use of all-purpose cleaners and other degreasing detergents.

CORD

4 m textile cord (gold glass - green cord / smoked glass - black cord / white glass - white cord).

CANOPY

Included, black or white color, H: 7,7 x Ø: 9 cm 0,04 kg

DIMMABLE FUNCTION

No

VOLTAGE

220-240V

MAX LOAD

12 W

FREQUENCY

50/60 Hz

IP RATING

IP20

CLASSIFICATION

Class II

SOCKET

G4

LIGHT SOURCE - INCLUDED

LED included: SMD2835, Art. No.: 502069 15x

Power: 0,4 W

CCT: 3 000 K

Output: 40 lm

Life Span: 10 000 h

CRI: ~ 80

GENERAL STANDARD & CERTIFICATES

EN 60598-2-1: 1989

EN 60598-1: 2015

EN 62031: 2008+A1:2013+A2:2015

EN 62471: 2008

EN 62493: 2015

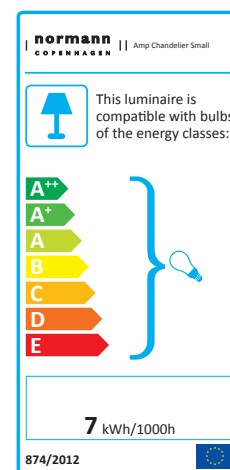

COLOR



White Glass /
White Marble



Smoke Glass /
Black Marble



Gold Glass /
Green Marble

Amp Chandelier Large - EU Version

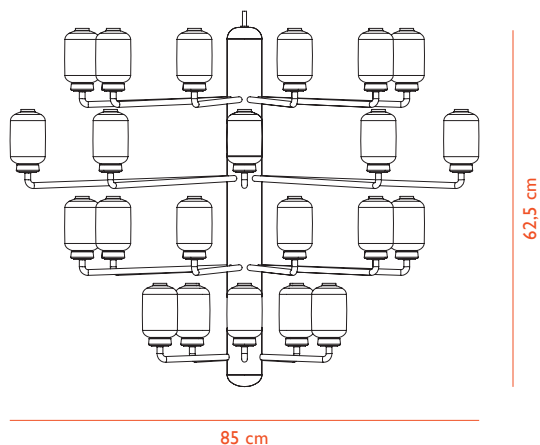
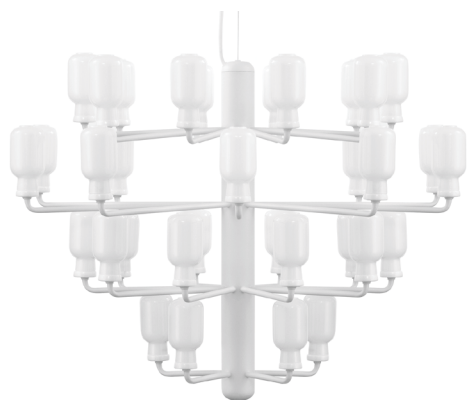

DESCRIPTION

Amp is a collection of lamps inspired by old tube amplifiers from the 1960s. The sophisticated range is characterized by its high-quality materials of glass, brass and marble that add a visual fragility and sensuous heaviness. Amp has a nostalgic and at the same time, contemporary feel.

DESIGN

Simon Legald, 2014

MATERIAL

Glass / Marble / Brass Plated Steel

CONSTRUCTION

The Amp collection consists of five lamps, which all follow the simple construction of a glass shade slipped over a marble or brass base. The shape of each part ensures stability and easy handling.

MAINTENANCE

Clean with damp cloth. Avoid use of all-purpose cleaners and other degreasing detergents.

CORD

4 m textile cord (gold glass - green cord / smoked glass - black cord / white glass - white cord).

CANOPY

Included, black or white color, H: 7,7 x Ø: 9 cm 0,04 kg

DIMMABLE FUNCTION

No

VOLTAGE

220-240 V

MAX LOAD

16 W

FREQUENCY

50/60 Hz

IP RATING

IP20

CLASSIFICATION

Class II

SOCKET

G4

LIGHT SOURCE - INCLUDED

LED included: SMD2835, Art. No.: 502069 35x

Power: 0,4 W

CCT: 3000 K

Output: 40 lm

Life Span: 10 000 h

CRI: ~ 80

GENERAL STANDARD & CERTIFICATES

EN 55015:2013

EN 61000-3-2:2014

EN 61000-3-3:2013

EN 61547:2009

EN 62493:2010

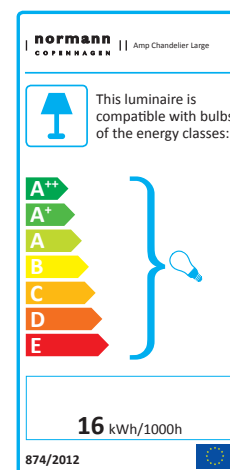

COLOR



White Glass /
White Marble



Smoke Glass /
Black Marble



Gold Glass /
Green Marble

AMP
US Version



Amp Pendant Small - US Version

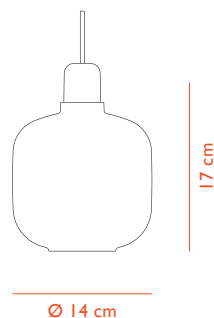

DESCRIPTION

Amp is a collection of lamps inspired by old tube amplifiers from the 1960s. The sophisticated range is characterized by its high-quality materials of glass, brass and marble that add a visual fragility and sensuous heaviness. Amp has a nostalgic and at the same time, contemporary feel.

DESIGN

Simon Legald, 2014

MATERIAL

Glass / Marble / Brass Plated Steel

CONSTRUCTION

The Amp collection consists of five lamps, which all follow the simple construction of a glass shade slipped over a marble or brass base. The shape of each part ensures stability and easy handling.

MAINTENANCE

Clean with damp cloth. Avoid use of all-purpose cleaners and other degreasing detergents.

CORD

4 m textile cord (gold glass - green cord / smoked glass - black cord / white glass - white cord).

CANOPY

Included, black or white color, H: 7,7 x Ø: 9 cm 0,04 kg

DIMMABLE FUNCTION

Yes - with dimmable light source. Ensure the dimmer is suitable for LED.

VOLTAGE

120V

MAX LOAD

40 W

FREQUENCY

60 Hz

IP RATING

IP20

CLASSIFICATION

Class I

SOCKET

E12

LIGHT SOURCE - RECOMMENDED

Art. No.: 504060 LED E12 US, dimmable

Power: 3,5 W

CCT: 2000K

Output: 100 lm

Life Span: 15 000 h

CRI: > 90

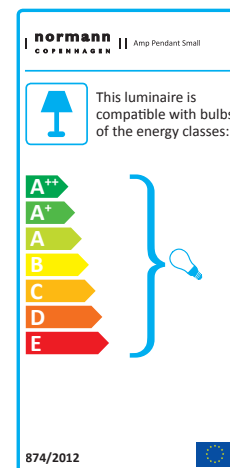

 IP20 



COLOR



White Glass /
White Marble



Smoke Glass /
Black Marble



Gold Glass /
Green Marble



White Glass /
Brass



Smoke Glass /
Brass

Amp Pendant Large - US Version

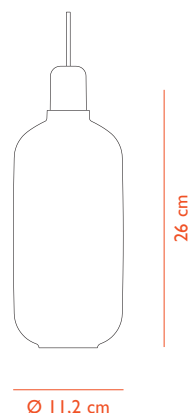

DESCRIPTION

Amp is a collection of lamps inspired by old tube amplifiers from the 1960s. The sophisticated range is characterized by its high-quality materials of glass, brass and marble that add a visual fragility and sensuous heaviness. Amp has a nostalgic and at the same time, contemporary feel.

DESIGN

Simon Legald, 2014

MATERIAL

Glass / Marble / Brass Plated Steel

CONSTRUCTION

The Amp collection consists of five lamps, which all follow the simple construction of a glass shade slipped over a marble or brass base. The shape of each part ensures stability and easy handling.

MAINTENANCE

Clean with damp cloth. Avoid use of all-purpose cleaners and other degreasing detergents.

CORD

4 m textile cord (gold glass - green cord / smoked glass - black cord / white glass - white cord).

CANOPY

Included, black or white color, H: 7,7 x Ø: 9 cm 0,04 kg

DIMMABLE FUNCTION

Yes - with dimmable light source. Ensure the dimmer is suitable for LED.

VOLTAGE

120V

MAX LOAD

40 W

FREQUENCY

60 Hz

IP RATING

IP20

CLASSIFICATION

Class I

SOCKET

E12

LIGHT SOURCE - RECOMMENDED

Art. No.: 504060 LED E12 US, dimmable

Power: 3,5 W

CCT: 2000K

Output: 100 lm

Life Span: 15 000 h

CRI: > 90

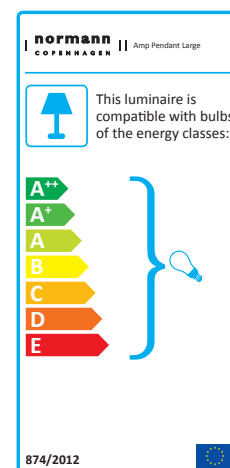

 IP20 



COLOR



White Glass /
White Marble



Smoke Glass /
Black Marble



Gold Glass /
Green Marble



White Glass /
Brass



Smoke Glass /
Brass

Amp Table Lamp - US Version

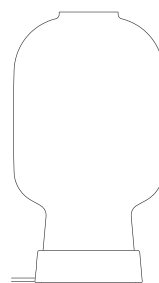

26,5 cm

Ø 14 cm

DESCRIPTION

Amp is a collection of lamps inspired by old tube amplifiers from the 1960s. The sophisticated range is characterized by its high-quality materials of glass, brass and marble that add a visual fragility and sensuous heaviness. Amp has a nostalgic and at the same time, contemporary feel.

DESIGN

Simon Legald, 2014

MATERIAL

Glass / Marble / Brass Plated Steel

CONSTRUCTION

The Amp collection consists of five lamps, which all follow the simple construction of a glass shade slipped over a marble or brass base. The shape of each part ensures stability and easy handling.

MAINTENANCE

Clean with damp cloth. Avoid use of all-purpose cleaners and other degreasing detergents.

CORD

2 m textile cord with switch (gold glass - green cord / smoked glass - black cord / white glass - white cord).

DIMMABLE FUNCTION

No

VOLTAGE

120 V

MAX LOAD

40 W

FREQUENCY

60 Hz

IP RATING

IP20

CLASSIFICATION

Class II

SOCKET

E12

LIGHT SOURCE - RECOMMENDED

Art. No.: 504060 LED E12 US, dimmable

Power: 3,5 W

CCT: 2000 K

Output: 100 lm

Life Span: 15 000 h

CRI: > 90

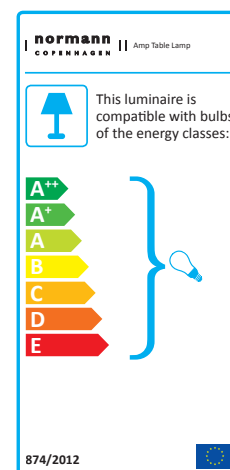

COLOR



White Glass /
White Marble



Smoke Glass /
Black Marble



Gold Glass /
Green Marble



White Glass /
Brass



Smoke Glass /
Brass

Amp Chandelier Small - US Version

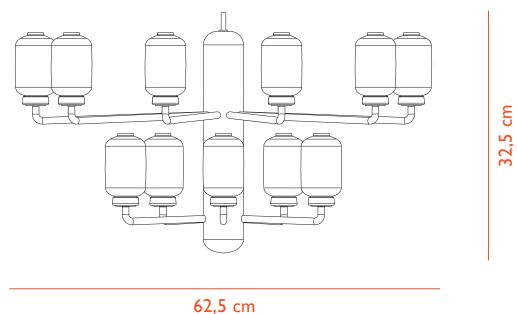
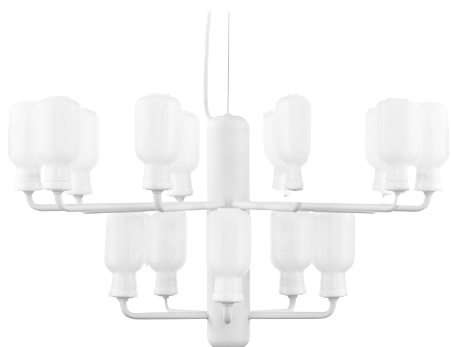

DESCRIPTION

Amp is a collection of lamps inspired by old tube amplifiers from the 1960s. The sophisticated range is characterized by its high-quality materials of glass, brass and marble that add a visual fragility and sensuous heaviness. Amp has a nostalgic and at the same time, contemporary feel.

DESIGN

Simon Legald, 2014

MATERIAL

Glass / Marble / Brass Plated Steel

CONSTRUCTION

The Amp collection consists of five lamps, which all follow the simple construction of a glass shade slipped over a marble or brass base. The shape of each part ensures stability and easy handling.

MAINTENANCE

Clean with damp cloth. Avoid use of all-purpose cleaners and other degreasing detergents.

CORD

4 m textile cord (gold glass - green cord / smoked glass - black cord / white glass - white cord).

CANOPY

Included, black or white color, H: 7,7 x Ø: 9 cm 0,04 kg

DIMMABLE FUNCTION

No

VOLTAGE

120V

MAX LOAD

12 W

FREQUENCY

60 Hz

IP RATING

IP20

CLASSIFICATION

Class I

SOCKET

G4

LIGHT SOURCE - INCLUDED

LED included: SMD2835, Art. No.: 502069 15x

Power: 0,4 W

CCT: 3 000 K

Output: 40 lm

Life Span: 10 000 h

CRI: ~ 80

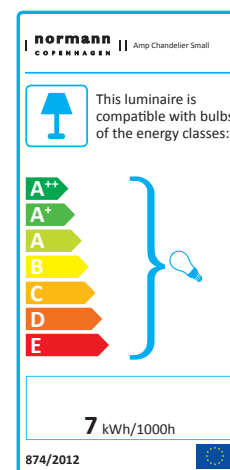

UL IP20



COLOR



White Glass /
White Marble



Smoke Glass /
Black Marble



Gold Glass /
Green Marble

Amp Chandelier Large - US Version

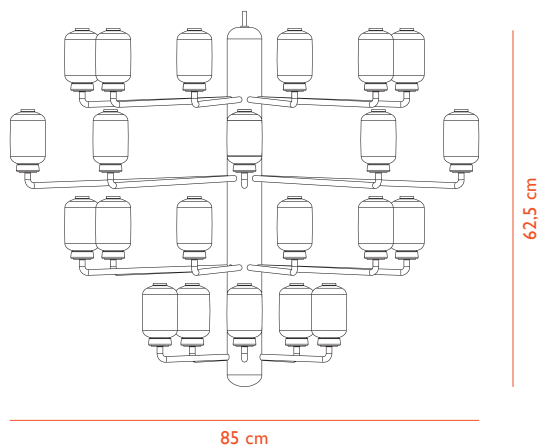
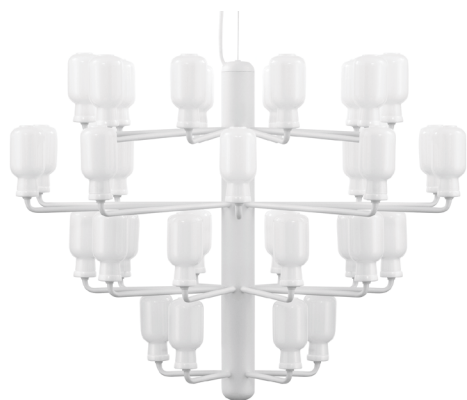

DESCRIPTION

Amp is a collection of lamps inspired by old tube amplifiers from the 1960s. The sophisticated range is characterized by its high-quality materials of glass, brass and marble that add a visual fragility and sensuous heaviness. Amp has a nostalgic and at the same time, contemporary feel.

DESIGN

Simon Legald, 2014

MATERIAL

Glass / Marble / Brass Plated Steel

CONSTRUCTION

The Amp collection consists of five lamps, which all follow the simple construction of a glass shade slipped over a marble or brass base. The shape of each part ensures stability and easy handling.

MAINTENANCE

Clean with damp cloth. Avoid use of all-purpose cleaners and other degreasing detergents.

CORD

4 m textile cord (gold glass - green cord / smoked glass - black cord / white glass - white cord).

CANOPY

Included, black or white color, H: 7,7 x Ø: 9 cm 0,04 kg

DIMMABLE FUNCTION

No

VOLTAGE

120V

MAX LOAD

16 W

FREQUENCY

60 Hz

IP RATING

IP20

CLASSIFICATION

Class I

SOCKET

G4

LIGHT SOURCE - INCLUDED

LED included: SMD2835, Art. No.: 502069 35x

Power: 0,4 W

CCT: 3 000 K

Output: 40 lm

Life Span: 10 000 h

CRI: ~ 80

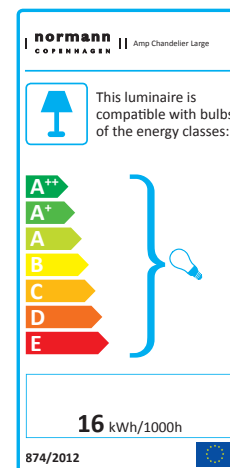

 IP20 

COLOR



White Glass /
White Marble



Smoke Glass /
Black Marble



Gold Glass /
Green Marble