

# GRANT

EU Version



**normann**  
COPENHAGEN

## Grant Pendant Ø23 cm - EU Version

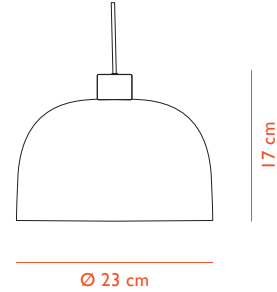

### DESCRIPTION

The Grant pendant lamps in two sizes provide ample opportunity for lighting up spaces of various size and character. Due to the dispersion lens, the pendants can be hung high without blinding. An aesthetic and space-optimizing lighting solution, the Grant wall lamps have arms that move from right to left and lampshades that can be tipped up and down, allowing the lamps to take up several different positions.

### DESIGN

Simon Legald, 2018

### MATERIAL

Brass Plated Steel / Black Plated Steel / Granite

### CONSTRUCTION

The six versions of Grant collection are constructed with a replaceable low-energy LED light source with dispersion lens, which is attached with small brass finger screws. The wall lamp versions can move from side to side (ca. 180 degrees). A ball joint connection on the table and floor lamp allows the lampshades to be positioned in diverse directions.

### MAINTENANCE

Clean with damp cloth. Avoid use of all-purpose cleaners and other degreasing detergents.

### CORD

4 m textile cord, black color.

### CANOPY

Included, black color, H: 7,7 x Ø: 9 cm 0,04 kg

### DIMMABLE FUNCTION

Yes. Ensure your dimmer is compatible with LED.

VOLTAGE  
220-240 V

MAX LOAD  
7 W

FREQUENCY  
50/60 Hz

IP RATING  
IP20

CLASSIFICATION  
Class II

SOCKET  
GX53

LIGHT SOURCE - INCLUDED  
LED included: GX53 Art. No.: 502028  
Power: 5W±10%  
CCT: 3 000 K  
Output: 400 lm ±10%  
Life Span: 15 000-20 000  
CRI: ~ 80

GENERAL STANDARD & CERTIFICATES  
EN 55015:2013  
EN 55015:2013+A1:2015  
EN 61547:2009  
EN 61000-3-2:2014  
EN 61000-3-3:2013

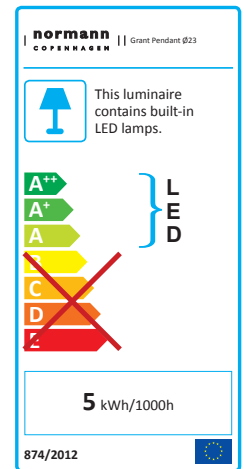

### COLOR

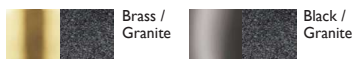

## Grant Pendant Ø45 cm - EU Version

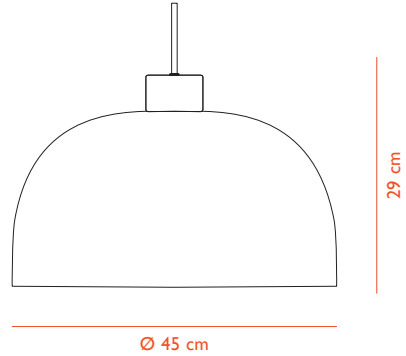

### DESCRIPTION

The Grant pendant lamps in two sizes provide ample opportunity for lighting up spaces of various size and character. Due to the dispersion lens, the pendants can be hung high without blinding. An aesthetic and space-optimizing lighting solution, the Grant wall lamps have arms that move from right to left and lampshades that can be tipped up and down, allowing the lamps to take up several different positions.

### DESIGN

Simon Legald, 2018

### MATERIAL

Brass Plated Steel / Black Plated Steel / Granite

### CONSTRUCTION

The six versions of Grant collection are constructed with a replaceable low-energy LED light source with dispersion lens, which is attached with small brass finger screws. The wall lamp versions can move from side to side (ca. 180 degrees). A ball joint connection on the table and floor lamp allows the lampshades to be positioned in diverse directions.

### MAINTENANCE

Clean with damp cloth. Avoid use of all-purpose cleaners and other degreasing detergents.

### CORD

4 m textile cord, black color.

### CANOPY

Included, black color, H: 7,7 x Ø: 9 cm 0,04 kg

### DIMMABLE FUNCTION

Yes. Ensure your dimmer is compatible with LED.

VOLTAGE  
220-240V

MAX LOAD  
7W

FREQUENCY  
50/60 Hz

IP RATING  
IP20

CLASSIFICATION  
Class II

SOCKET  
GX53

LIGHT SOURCE - INCLUDED  
LED included: GX53 Art. No.: 502029  
Power: 7W±10%  
CCT: 3 000K  
Output: 610lm ±10%  
Life Span: 15000-20000  
CRI: ~80

GENERAL STANDARD & CERTIFICATES  
EN 55015:2013  
EN 55015:2013+A1:2015  
EN 61547:2009  
EN 61000-3-2:2014  
EN 61000-3-3:2013

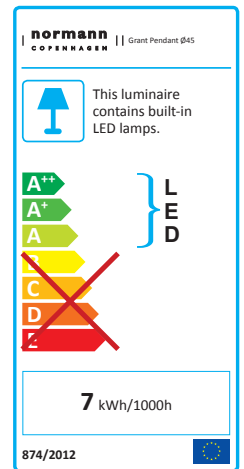

### COLOR

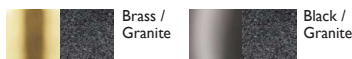

## Grant Table Lamp - EU Version

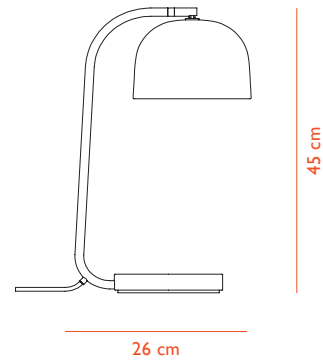

### DESCRIPTION

The Grant table lamp is a sophisticated desk lamp for the home office, but equally fit for the bedside table or living room sideboard. Tilt the lampshade up and down to direct the light and scroll on the cord's dimmer switch to go from soft ambience light to a bright reading light.

### DESIGN

Simon Legald, 2018

### MATERIAL

Brass Plated Steel / Black Plated Steel / Granite

### CONSTRUCTION

The six versions of Grant collection are constructed with a replaceable low-energy LED light source table with dispersion lens, which is attached with small brass finger screws. The wall lamp versions can move from side to side (ca. 180 degrees). A ball joint connection on the table and floor lamp allows the lampshades to be positioned in diverse directions.

### MAINTENANCE

Clean with damp cloth. Avoid use of all-purpose cleaners and other degreasing detergents.

### CORD

4 m textile cord with switch, black color.

### DIMMABLE FUNCTION

Yes.

VOLTAGE  
220-240 V

MAX LOAD  
7 W

FREQUENCY  
50/60 Hz

IP RATING  
IP20

CLASSIFICATION  
Class II

SOCKET  
GX53

### LIGHT SOURCE - INCLUDED

LED included: GX53 Art. No.: 502027  
Power: 4W±10%  
CCT: 3 000K  
Output: 300lm ±10%  
Life Span: 15 000-20 000  
CRI: ~80

### GENERAL STANDARD & CERTIFICATES

EN 55015:2013  
EN 55015:2013+A1:2015  
EN 61547:2009  
EN 61000-3-2:2014  
EN 61000-3-3:2013

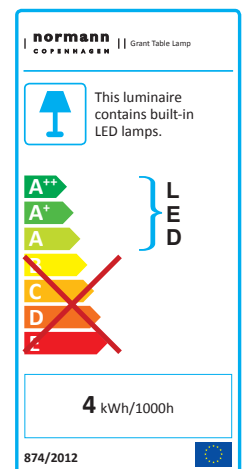

### COLOR

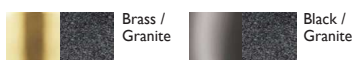

## Grant Floor Lamp - EU Version

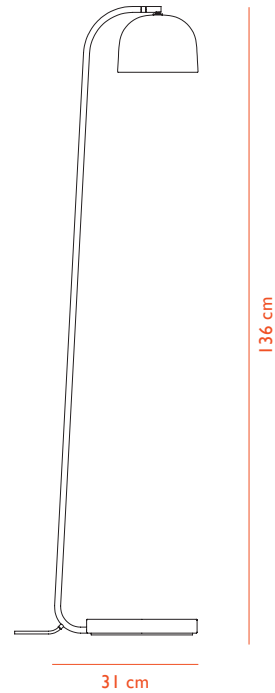

### DESCRIPTION

Sharing the same features as the Grant table lamp, an adjustable shade and dimmer switch, the Grant floor lamp is ideal as a reading lamp or for lighting up dark corners.

### DESIGN

Simon Legald, 2018

### MATERIAL

Brass Plated Steel / Black Plated Steel / Granite

### CONSTRUCTION

The six versions of Grant collection are constructed with a replaceable low-energy LED light source with dispersion lens, which is attached with small brass finger screws. The wall lamp versions can move from side to side (ca. 180 degrees). A ball joint connection on the table and floor lamp allows the lampshades to be positioned in diverse directions.

### MAINTENANCE

Clean with damp cloth. Avoid use of all-purpose cleaners and other degreasing detergents.

### CORD

4 m textile cord with switch, black color.

### DIMMABLE FUNCTION

Yes.

VOLTAGE  
220-240 V

MAX LOAD  
7 W

FREQUENCY  
50/60 Hz

IP RATING  
IP20

CLASSIFICATION  
Class II

SOCKET  
GX53

### LIGHT SOURCE - INCLUDED

LED included: GX53 Art. No.: 502027  
Power: 4W±10%  
CCT: 3 000K  
Output: 300lm ±10%  
Life Span: 15000-20000  
CRI: ~80

### GENERAL STANDARD & CERTIFICATES

EN 55015:2013  
EN 55015:2013+A1:2015  
EN 61547:2009  
EN 61000-3-2:2014  
EN 61000-3-3:2013

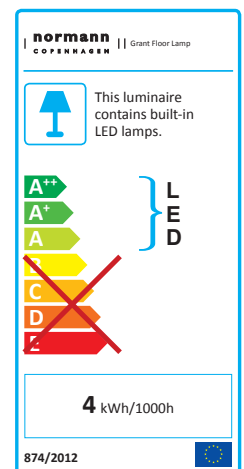

### COLOR

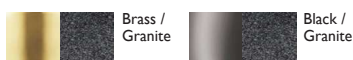

## Grant Wall Lamp 43 cm - EU Version

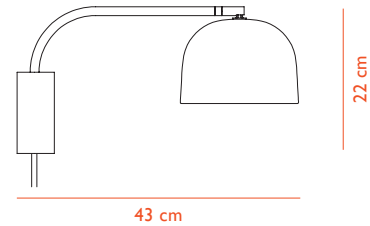

### DESCRIPTION

An aesthetic and space-optimizing lighting solution, the Grant wall lamps have arms that move from right to left and lampshades that can be tipped up and down, allowing the lamps to take up several different positions.

### DESIGN

Simon Legald, 2018

### MATERIAL

Brass Plated Steel / Black Plated Steel / Granite

### CONSTRUCTION

The six versions of Grant collection are constructed with a replaceable low-energy LED light source with dispersion lens, which is attached with small brass finger screws. The wall lamp versions can move from side to side (ca. 180 degrees). A ball joint connection on the table and floor lamp allows the lampshades to be positioned in diverse directions.

### MAINTENANCE

Clean with damp cloth. Avoid use of all-purpose cleaners and other degreasing detergents.

### CORD

4 m textile cord with switch, black color.

### DIMMABLE FUNCTION

Yes.

VOLTAGE  
220-240 V

MAX LOAD  
7 W

FREQUENCY  
50/60 Hz

IP RATING  
IP20

CLASSIFICATION  
Class II

SOCKET  
GX53

### LIGHT SOURCE - INCLUDED

LED included: GX53 Art. No.: 502027  
Power: 4W±10%  
CCT: 3 000K  
Output: 300lm ±10%  
Life Span: 15000-20000  
CRI: ~80

### GENERAL STANDARD & CERTIFICATES

EN 55015:2013  
EN 55015:2013+A1:2015  
EN 61547:2009  
EN 61000-3-2:2014  
EN 61000-3-3:2013

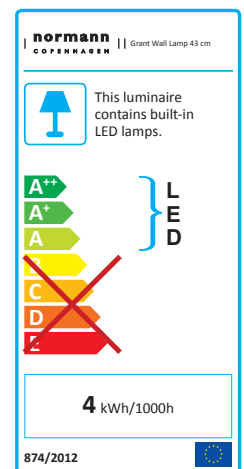

### COLOR

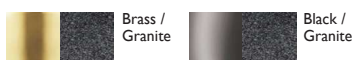

# Grant Wall Lamp 111 cm - EU Version

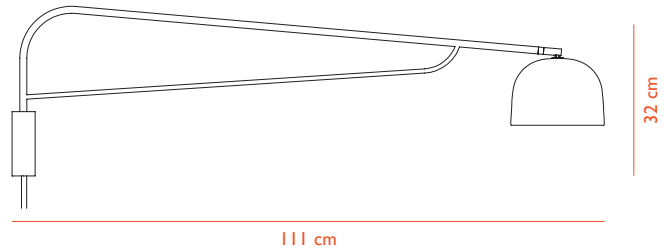

## DESCRIPTION

An aesthetic and space-optimizing lighting solution, the Grant wall lamps have arms that move from right to left and lampshades that can be tipped up and down, allowing the lamps to take up several different positions.

## DESIGN

Simon Legald, 2018

## MATERIAL

Brass Plated Steel / Black Plated Steel / Granite

## CONSTRUCTION

The six versions of Grant collection are constructed with a replaceable low-energy LED light source with dispersion lens, which is attached with small brass finger screws. The wall lamp versions can move from side to side (ca. 180 degrees). A ball joint connection on the table and floor lamp allows the lampshades to be positioned in diverse directions.

## MAINTENANCE

Clean with damp cloth. Avoid use of all-purpose cleaners and other degreasing detergents.

## CORD

4 m textile cord with switch, black color.

## DIMMABLE FUNCTION

Yes.

VOLTAGE  
220-240 V

MAX LOAD  
7 W

FREQUENCY  
50/60 Hz

IP RATING  
IP20

CLASSIFICATION  
Class II

SOCKET  
GX53

## LIGHT SOURCE - INCLUDED

LED included: GX53 Art. No.: 502027  
Power: 4W±10%  
CCT: 3 000K  
Output: 300lm ±10%  
Life Span: 15000-20000  
CRI: ~80

## GENERAL STANDARD & CERTIFICATES

EN 55015:2013  
EN 55015:2013+A1:2015  
EN 61547:2009  
EN 61000-3-2:2014  
EN 61000-3-3:2013

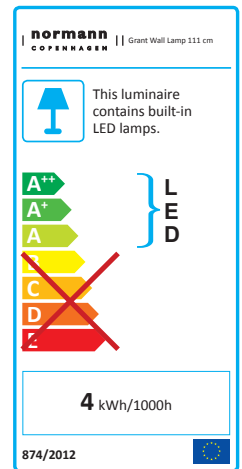

## COLOR

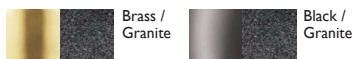

# GRANT

US Version



**normann**  
COPENHAGEN



## Grant Pendant Ø23 cm - US Version

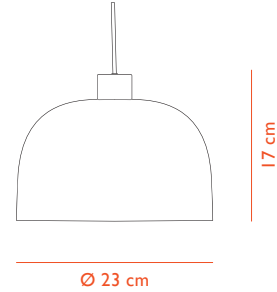

### DESCRIPTION

The Grant pendant lamps in two sizes provide ample opportunity for lighting up spaces of various size and character. Due to the dispersion lens, the pendants can be hung high without blinding. An aesthetic and space-optimizing lighting solution, the Grant wall lamps have arms that move from right to left and lampshades that can be tipped up and down, allowing the lamps to take up several different positions.

### DESIGN

Simon Legald, 2018

### MATERIAL

Brass Plated Steel / Black Plated Steel / Granite

### CONSTRUCTION

The six versions of Grant collection are constructed with a replaceable low-energy LED light source with dispersion lens, which is attached with small brass finger screws. The wall lamp versions can move from side to side (ca. 180 degrees). A ball joint connection on the table and floor lamp allows the lampshades to be positioned in diverse directions.

### MAINTENANCE

Clean with damp cloth. Avoid use of all-purpose cleaners and other degreasing detergents.

### CORD

4 m textile cord, black color.

### CANOPY

Included, black color, H: 7,7 x Ø: 9 cm 0,04 kg

### DIMMABLE FUNCTION

Yes - Ensure your dimmer is compatible with LED.

VOLTAGE  
120V

MAX LOAD  
7W

FREQUENCY  
60 Hz

IP RATING  
IP20

CLASSIFICATION  
Class I

SOCKET  
GX53

LIGHT SOURCE - INCLUDED  
LED included: GX53 Art. No.: 502028  
Power: 5W±10%  
CCT: 3 000K  
Output: 400lm ±10%  
Life Span: 15 000-20 000  
CRI: ~80

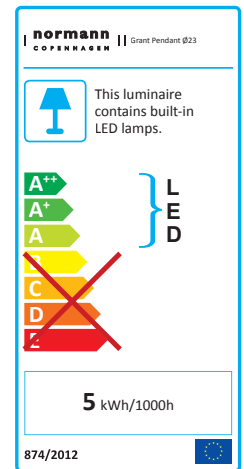

### COLOR

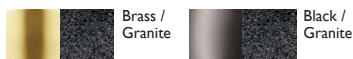

# Grant Pendant Ø45 cm - US Version

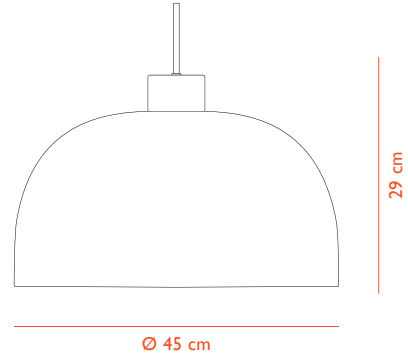

## DESCRIPTION

The Grant pendant lamps in two sizes provide ample opportunity for lighting up spaces of various size and character. Due to the dispersion lens, the pendants can be hung high without blinding. An aesthetic and space-optimizing lighting solution, the Grant wall lamps have arms that move from right to left and lampshades that can be tipped up and down, allowing the lamps to take up several different positions.

## DESIGN

Simon Legald, 2018

## MATERIAL

Brass Plated Steel / Black Plated Steel / Granite

## CONSTRUCTION

The six versions of Grant collection are constructed with a replaceable low-energy LED light source with dispersion lens, which is attached with small brass finger screws. The wall lamp versions can move from side to side (ca. 180 degrees). A ball joint connection on the table and floor lamp allows the lampshades to be positioned in diverse directions.

## MAINTENANCE

Clean with damp cloth. Avoid use of all-purpose cleaners and other degreasing detergents.

## CORD

4 m textile cord, black color.

## CANOPY

Included, black color, H: 7,7 x Ø: 9 cm 0,04 kg

## DIMMABLE FUNCTION

Yes - Ensure your dimmer is compatible with LED.

VOLTAGE  
120V

MAX LOAD  
7W

FREQUENCY  
60 Hz

IP RATING  
IP20

CLASSIFICATION  
Class I

SOCKET  
GX53

LIGHT SOURCE - INCLUDED  
LED included: GX53 Art. No.: 502029  
Power: 7W±10%  
CCT: 3 000K  
Output: 610lm ±10%  
Life Span: 15 000-20 000  
CRI: ~ 80

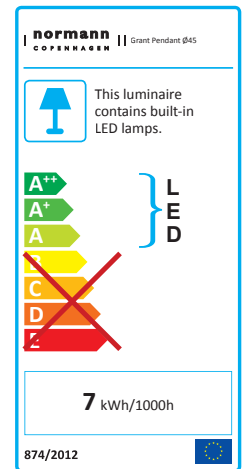

## COLOR

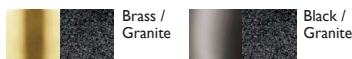

## Grant Table Lamp - US Version

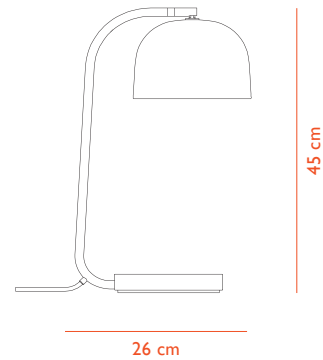

### DESCRIPTION

The Grant table lamp is a sophisticated desk lamp for the home office, but equally fit for the bedside table or living room sideboard. Tilt the lampshade up and down to direct the light and scroll on the cord's dimmer switch to go from soft ambience light to a bright reading light.

### DESIGN

Simon Legald, 2018

### MATERIAL

Brass Plated Steel / Black Plated Steel / Granite

### CONSTRUCTION

The six versions of Grant collection are constructed with a replaceable low-energy LED light source with dispersion lens, which is attached with small brass finger screws. The wall lamp versions can move from side to side (ca. 180 degrees). A ball joint connection on the table and floor lamp allows the lampshades to be positioned in diverse directions.

### MAINTENANCE

Clean with damp cloth. Avoid use of all-purpose cleaners and other degreasing detergents.

### CORD

4 m textile cord with switch, black color.

### DIMMABLE FUNCTION

Yes.

### VOLTAGE

120V

### MAX LOAD

7W

### FREQUENCY

60 Hz

### IP RATING

IP20

### CLASSIFICATION

Class I

### SOCKET

GX53

### LIGHT SOURCE - INCLUDED

LED included: GX53 Art. No.: 502027

Power: 4W ± 10%

CCT: 3 000K

Output: 300lm ± 10%

Life Span: 15 000-20 000

CRI: ~ 80

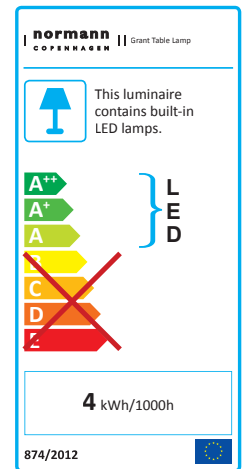

### COLOR



## Grant Floor Lamp - US Version

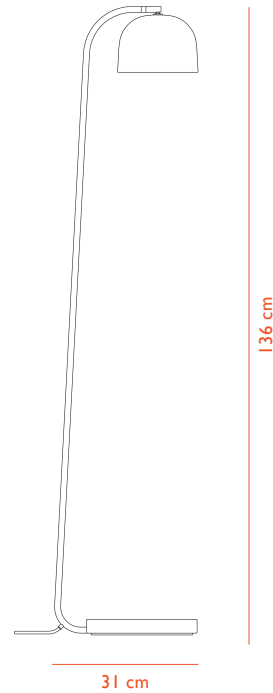

### DESCRIPTION

Sharing the same features as the Grant table lamp, an adjustable shade and dimmer switch, the Grant floor lamp is ideal as a reading lamp or for lighting up dark corners.

### DESIGN

Simon Legald, 2018

### MATERIAL

Brass Plated Steel / Black Plated Steel / Granite

### CONSTRUCTION

The six versions of Grant collection are constructed with a replaceable low-energy LED light source with dispersion lens, which is attached with small brass finger screws. The wall lamp versions can move from side to side (ca. 180 degrees). A ball joint connection on the table and floor lamp allows the lampshades to be positioned in diverse directions.

### MAINTENANCE

Clean with damp cloth. Avoid use of all-purpose cleaners and other degreasing detergents.

### CORD

4 m textile cord with switch, black color.

### DIMMABLE FUNCTION

Yes.

### VOLTAGE

120V

### MAX LOAD

7W

### FREQUENCY

60 Hz

### IP RATING

IP20

### CLASSIFICATION

Class I

### SOCKET

GX53

### LIGHT SOURCE - INCLUDED

LED included: GX53 Art. No.: 502027

Power: 4W±10%

CCT: 3 000K

Output: 300lm ±10%

Life Span: 15 000-20 000

CRI: ~80

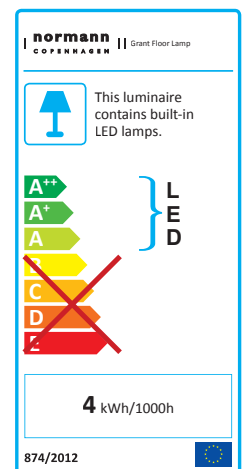

### COLOR

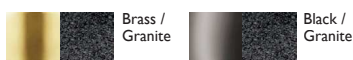

# Grant Wall Lamp 43 cm - US Version

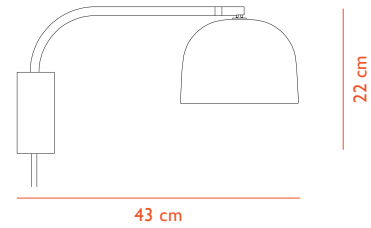

## DESCRIPTION

An aesthetic and space-optimizing lighting solution, the Grant wall lamps have arms that move from right to left and lampshades that can be tipped up and down, allowing the lamps to take up several different positions.

## DESIGN

Simon Legald, 2018

## MATERIAL

Brass Plated Steel / Black Plated Steel / Granite

## CONSTRUCTION

The six versions of Grant collection are constructed with a replaceable low-energy LED light source with dispersion lens, which is attached with small brass finger screws. The wall lamp versions can move from side to side (ca. 180 degrees). A ball joint connection on the table and floor lamp allows the lampshades to be positioned in diverse directions.

## MAINTENANCE

Clean with damp cloth. Avoid use of all-purpose cleaners and other degreasing detergents.

## CORD

4 m textile cord with switch, black color.

## DIMMABLE FUNCTION

Yes.

## VOLTAGE

120V

## MAX LOAD

7W

## FREQUENCY

60 Hz

## IP RATING

IP20

## CLASSIFICATION

Class I

## SOCKET

GX53

## LIGHT SOURCE - INCLUDED

LED included: GX53 Art. No.: 502027

Power: 4W±10%

CCT: 3 000K

Output: 300lm ±10%

Life Span: 15000-20000

CRI: ~80

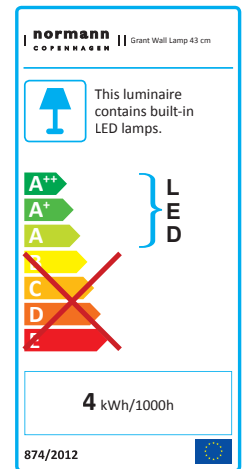

## COLOR

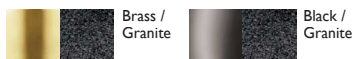

# Grant Wall Lamp 111 cm - US Version

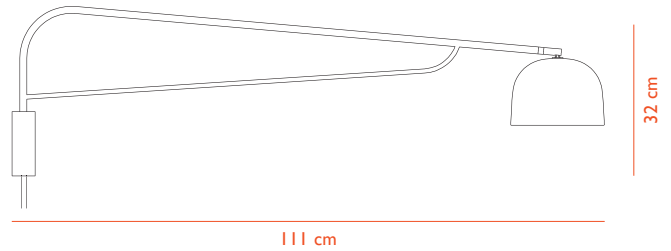

## DESCRIPTION

An aesthetic and space-optimizing lighting solution, the Grant wall lamps have arms that move from right to left and lampshades that can be tipped up and down, allowing the lamps to take up several different positions.

## DESIGN

Simon Legald, 2018

## MATERIAL

Brass Plated Steel / Black Plated Steel / Granite

## CONSTRUCTION

The six versions of Grant collection are constructed with a replaceable low-energy LED light source with dispersion lens, which is attached with small brass finger screws. The wall lamp versions can move from side to side (ca. 180 degrees). A ball joint connection on the table and floor lamp allows the lampshades to be positioned in diverse directions.

## MAINTENANCE

Clean with damp cloth. Avoid use of all-purpose cleaners and other degreasing detergents.

## CORD

4 m textile cord with switch, black color.

## DIMMABLE FUNCTION

Yes.

## VOLTAGE

120V

## MAX LOAD

7W

## FREQUENCY

60 Hz

## IP RATING

IP20

## CLASSIFICATION

Class I

## SOCKET

GX53

## LIGHT SOURCE - INCLUDED

LED included: GX53 Art. No.: 502027

Power: 4W±10%

CCT: 3 000K

Output: 300lm ±10%

Life Span: 15000-20000

CRI: ~80

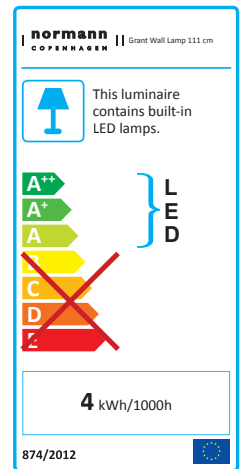

## COLOR

