



DESIGN: NUMEN / FOR USE

The basis of the system is the characteristic profile of a chair which, defined by two triangular prisms, ensures maximum foam thickness on the rear of the seat and the backseat's lumbar area. The metal is bent at a specified geometry and is upholstered with the moulded foam, resultis in a unified pulsating form. As a result of the triangulation, the solid oak legs thin towards the bottom, thus transforming the square cross-section of the top of the legs into their bases' triangle.

SEAT / SUPPORT	moulded foam, metal frame
UPHOLSTERY	fabric
LEGS	solid wood
FINISH	high quality oil / acrylic lacquer



reddot design award
winner 2015

RED DOT DESIGN
AWARD 2015 WINNER

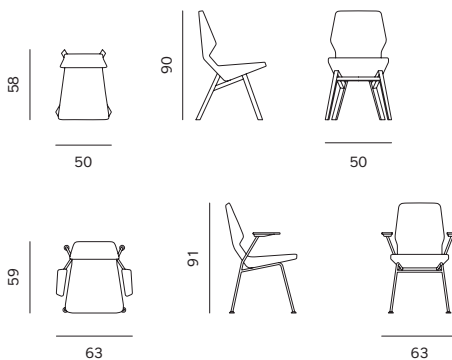

CHAIR / STOLICA

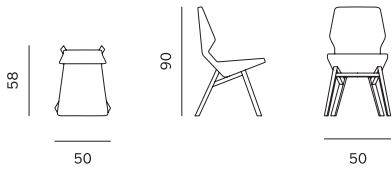

CHAIR METAL / STOLICA METALNA

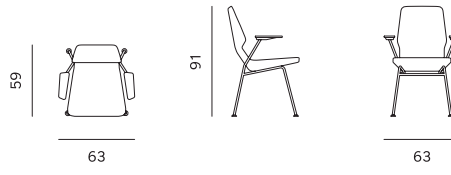

LOUNGE CHAIR / FOTELJA

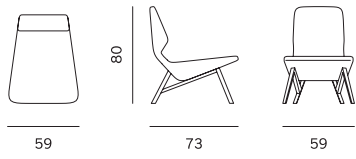

ARMCHAIR METAL / FOTELJA METALNA

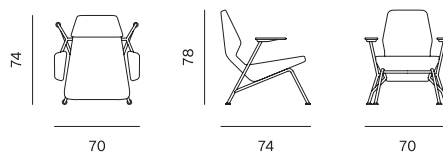

ARMCHAIR / FOTELJA S RUKONASLONIMA

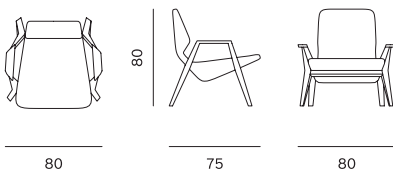

SMALL TABLES / STOLIĆI

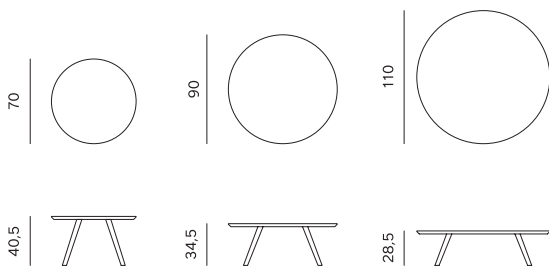

DINING TABLE / STOL

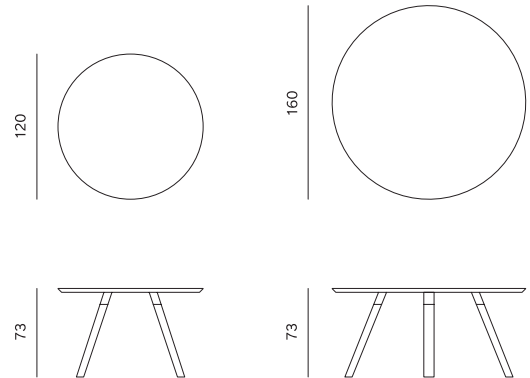

DINING TABLE / STOL

